

# 191 K SP K Shake



---

# CARPIGIANI **SOFT SERVE CONSULTING**

---

**CARPIGIANI SOFT SERVE CONSULTING** consultants transform your idea into a successful business!



**Machine  
Configuration  
& Settings**

**Food  
Style**

**Operations  
Management**

**Mix & Recipe  
Development**



# Fundamentals and Advantages

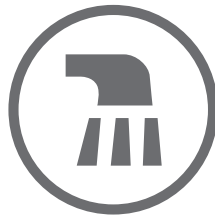



## PERFORMANCE AND QUALITY

It is possible to make classic, neutral or flavored milkshakes.



### Creamy Milk Shake Production

Thanks to the H-O-T system and the type of feed (gravity or pump), users can set the desired consistency for classic milkshakes or creamy modern shakes with more pronounced ice crystals.



## PERFORMANCE AND QUALITY

### Hard-O-Tronic®.

The electronic control system that allows you to easily change the consistency of the shake according to the type of product inserted or desired style.

**Start Up Phase.** Initial phase, in which Carpigiani software prepares the mixture by modulating the cylinder temperature to create the ideal compact, creamy shake structure with the presence of ice crystals.

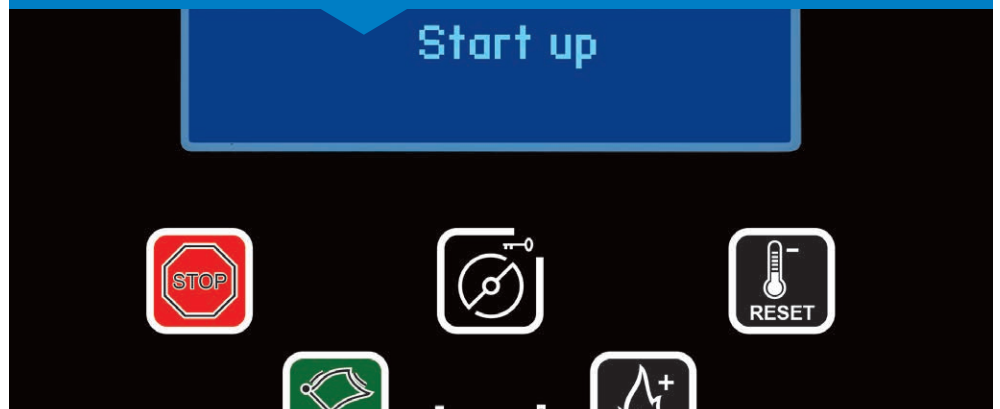

Legend: ONLY Optional upon purchase Optional available even after purchase



## PERFORMANCE AND QUALITY

### Choice of **MIX FEEDING SYSTEM**

#### **Pump - Version P**

Ideal for high volume production of creamy and compact shakes. Ability to modulate characteristics of the shakes. Thanks to the pump regulator and pressurized steel pump with advanced thermoplastic polymer gears.



**Gravity - Version G (only for 191 K models).** For unique styles of creamy and compact shakes. The different diameters of the holes on the feeding tube naturally dose the mixture with overrun.



### **BEATER**

#### **High Efficiency Beater**

The High efficiency beater is designed for creating shake products. The metal body and interchangeable plastic flap allows user to adjust the Ice crystal size for a dedicated shake style.



#### **Direct expansion cylinder**

Optimizes the refrigeration process, speeding up freezing times and eliminating energy waste. Thanks to the new position of the feed hole, the pre-loading operation is simple and safe. The dimensions of this cylinder, larger than the cylinders of soft machines, are functional to the high production capacity.



Legend:  ONLY Optional upon purchase  Optional available even after purchase



# CONVENIENCE

New solutions for maximum **convenience** during use

## Tank Agitator

Prevents product stratification during storage and improves heat exchange during pasteurization.



**Adjustable dispensing speed (for 191 K models).** Adjustable delivery flow to meet all volume and speed needs.



## Optional Mixer Shake

Integrated mixer to mix toppings and inclusions in the shake.

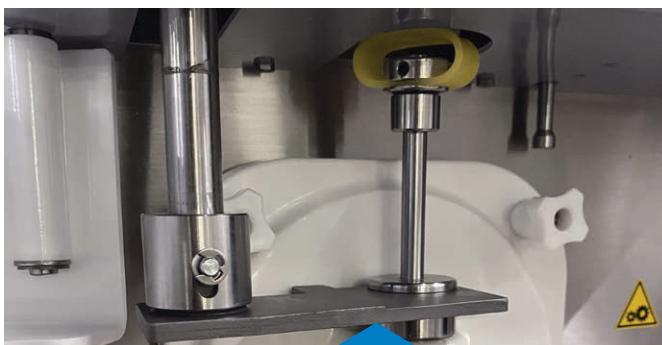

**Automatic delivery closure (only for K Shake).** This machine is equipped with a portion control. The system delivers the correct portion required, regardless of the size of the cup.

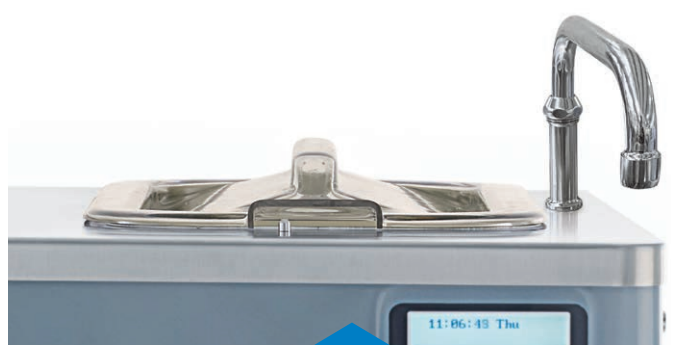

**Optional Dry Filling system (only for K Shake).** Automatic water filling system in the tanks, to mix the powders directly in the tank, saving time and reducing the possibility of dosing errors.



Legend: ONLY Optional upon purchase Optional available even after purchase



# CONVENIENCE

**Optional Only You (only for 191 K).** Customize the front panel of the machine by choosing from the array of colors found in the dedicated catalog.

**Optional Total Only You (only for 191 K).** The machine can be completely colored for a consistent look representative of the style of the product, location or brand. Choosing from the array of colors found in the dedicated catalog.



**Optional Cabinet (only for 191 K).** Easily position the machine inside the shop. Thanks to the cabinet, it is possible to move the machine easily and safely. Cabinet includes internal chamber to house materials.



**Automatic syrup dispensing system (only for K Shake).** At the time of dispensing, the operator can therefore choose between 5 shake options: neutral, or variegated with one of the 4 syrups. Thanks to the peristaltic pumps that can manage up to 4 syrups at the same time.



Scan the **QR Code** on the front of the machine to access the most up to date equipment information: Instruction Manual, Carpi Care kit & Carpi Clean kit.



## SAVINGS

New **high-performance** electric gearmotors and condensers

### Choice of **COOLING**

**Water Cooled machine.** Refrigeration system is cooled thanks to the inlet and outlet water circuit, conveniently located at the rear of the machine.



**Air cooled machine.** Installation space is optimized, thanks to the rear (191 K) and lower (K Shake) chimney, making it possible to place the machines side by side.



**Independent pump transmission** (P version). Extends the life of the pump and gears. Ensures flexibility with high performance.





## SAFETY

**More operational safety** and **more control** during production

**Cup level sensor (only for K Shake).** Automatic dispensing takes place in safety as the sensor detects the quantity of product to be dispensed based on the type of cup.

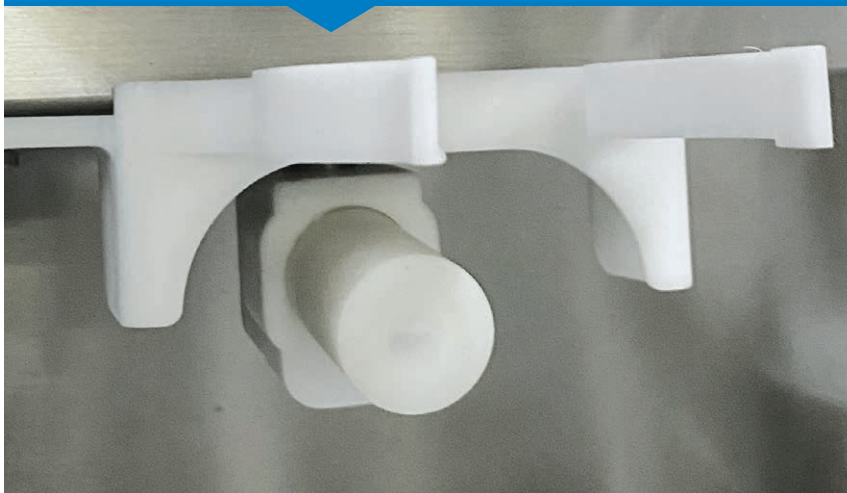

**Protective casing of the actuator (only for K Shake)** dedicated for automatic production. Prevents any interference from the operator.



**Ergonomic design.** Reduced risk of injury, with corners even rounder where the operator works.

**Black-out and water outage.** After a power or water failure, if the temperature-time parameters guarantee that the mixture has not undergone any alteration, the machine resumes the program in progress. Otherwise, if the machine is self-pasteurizing, a pasteurization cycle is automatically started, warning the operator with a message on the display. In the case of the non self-pasteurizing version, the machine requires washing.



### Optional Teorema

Guarantees facilitated assistance by providing on-line monitoring and diagnosis on a tablet, phone or PC wherever you are.



### Button lock

For added security, the display buttons can be locked to prevent accidental errors.





# HYGIENE

Easy cleaning,  
**guaranteed hygiene**

**Scheduled start.** Set the pasteurization, storage programs to automatically run at a convenient time for you, such as overnight and be fully functional the next day.

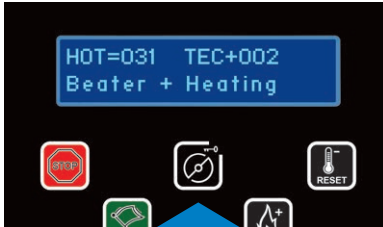

## Multifunctional Cleaning Button.

Possibility to activate or deactivate the pump and the beater individually or together according to cleaning needs. One of the functions is hot cleaning. By simultaneously activating the stirrer and the heating of the cylinder surface, the production grease residues are quickly dissolved.

## Optional Wash kit

Water Tap is added over the tank to facilitate cleaning.

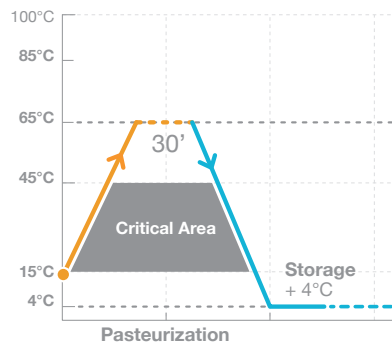

**Standard.** With the automatic self-pasteurization system you can choose when to wash the machine up to a maximum interval of 42 days. As a further guarantee of hygienic safety, if the operator does not perform the complete cleaning at the end of the set days, the machine goes into automatic block.



**Removable pump shaft.** Simplifies cleaning procedures, guaranteeing maximum hygiene and reliability.

## Carpi Care kit



Custom kits, designed to always keep your machine hygienically perfect.

## Carpi Clean kit



## Rubber tank lid (only for 191 K).

The lid can be opened to allow tank filling without having to remove it from the tank.

## Ergonomic lid (only for K Shake).

Ergonomic transparent tank lid for easy tank inspection.



# MACHINE CONFIGURATION

## TANK CONFIGURATION

### CHOOSE THE PRODUCT FEED SYSTEM

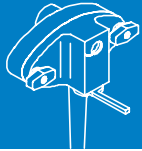

**Pump**

Optional



**Gravity**

(only for 191 K)

Optional



**Wash kit**



**Dry filling system**

(only for K shake)

## VISUAL CONFIGURATION

### CUSTOMIZE THE FRONT PANEL

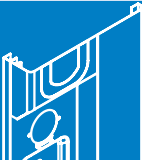

**Classic Plastic Front Panel**

(only for 191 K)

Optional

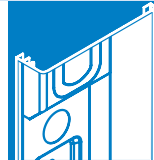

**Stainless Steel Front Panel**

(only for K Shake)

Optional



**Only You Personalization**

(only for 191 K)



**Total Only You Personalization**

(only for 191 K)

# MACHINE CONFIGURATION

## TECHNICAL CONFIGURATION

### CHOOSE THE TYPE OF CONDENSATION 191 K

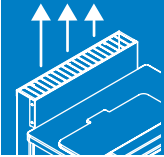

**Air Cooled machine**

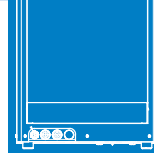

**Water Cooled machine**

### CHOOSE THE TYPE OF CONDENSATION K SHAKE

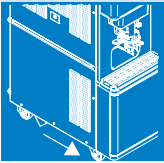

**Air Cooled machine**

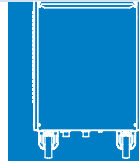

**Water Cooled machine**

### CHOOSE THE TYPE OF POWER SUPPLY



**Power supply  
Single-phase / Three-phase**

## ACCESSORIES CONFIGURATION

Optional



**Cabinet**  
(only for 191 K)

Optional



**Mixer**

Optional



**Teorema**

## WHO WE ARE

**Carpigiani Services.** Always by your side! The extensive Carpigiani service network is at your disposal with a widespread assistance network that guarantees a wide coverage of the territory with over 480 authorized service centers and 1500 specialized technicians around the world, for over 70 years guaranteeing a widespread, global presence. Carpigiani Services ensures rapid and professional assistance.



## WHAT WE OFFER

**Original spare parts.** Carpigiani original spare parts, manufactured in compliance with national and international food safety regulations, ensure the durability of the components and extend the life of the machine. They are the only ones able to guarantee efficiency and safety. Carpigiani original spare parts are guaranteed for 1 year.



### Carpi Care kit



6

MONTHS

Periodically ask your dealer **Carpi Care kit and Carpi Clean kit.** Dedicated kit of gaskets and brushes to keep each machine hygienic & clean.

### Carpi Clean kit

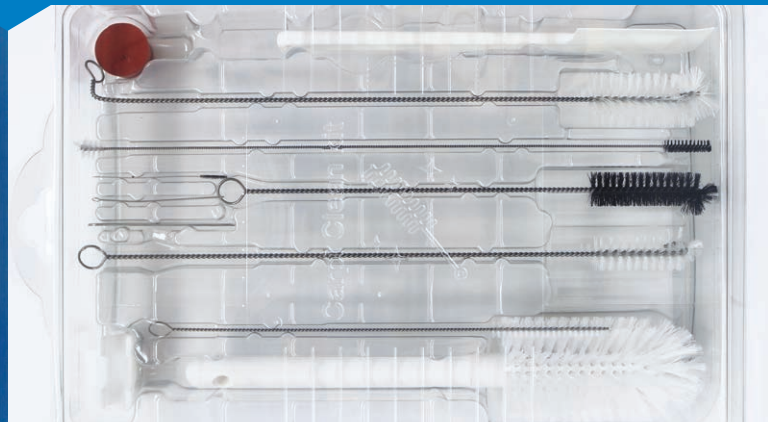

## WHAT WE OFFER

**Specialized technicians.** Carpigiani technicians are professionals who are always up-to-date thanks to solid and constant training courses that guarantee high levels of competence for any inspection, maintenance, cleaning and repair intervention.



**Preventive maintenance.** Thanks to periodic checks, entrusted to certified technicians, the machine can always work in optimal conditions, preventing any downtime.

**Extended Warranty.** Operate machine in complete tranquility, thanks to the Carpigiani extended warranty. In case of needs, in fact, Carpigiani technicians are able to restore machine operation with original spare parts.



**Scheduled Cleaning.** Possibility of entrusting the periodic cleaning of the machine to expert technicians.



**Teorema.** Teorema Remote Control and diagnosis system for remote monitoring of machine operation. The customer can access the machine via computer, tablet or mobile device to remotely monitor operations. Teorema also facilitates the assistance service: Carpigiani technicians are alerted on the configuration parameters as if they were operating directly on the machine.

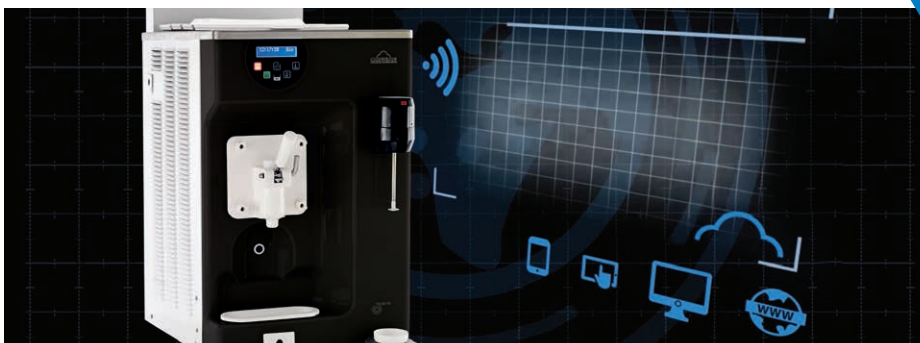

## Technical Data - Dimensions

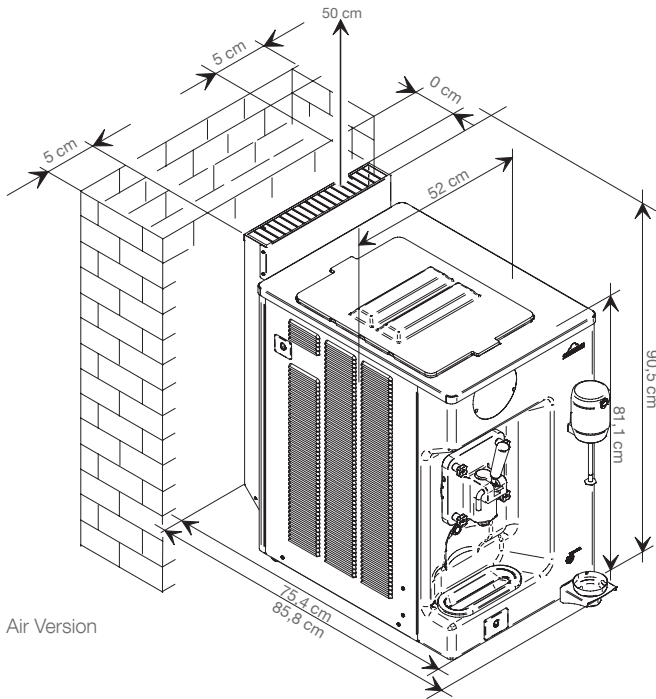

Air Version

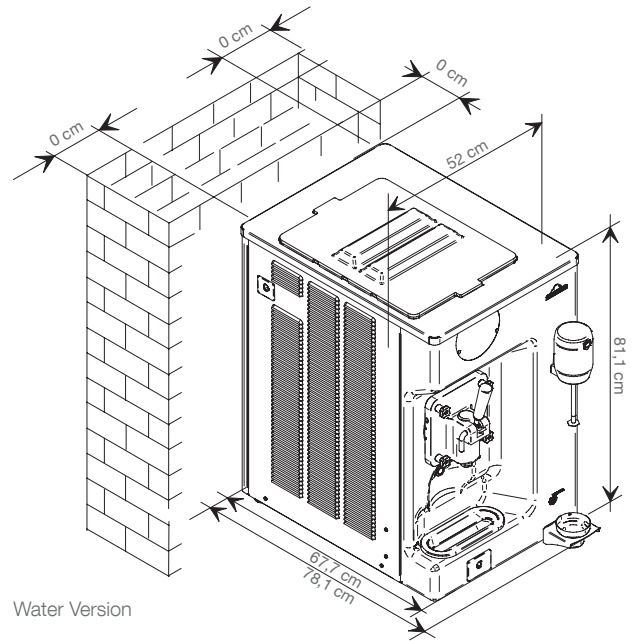

Water Version

191 K SP

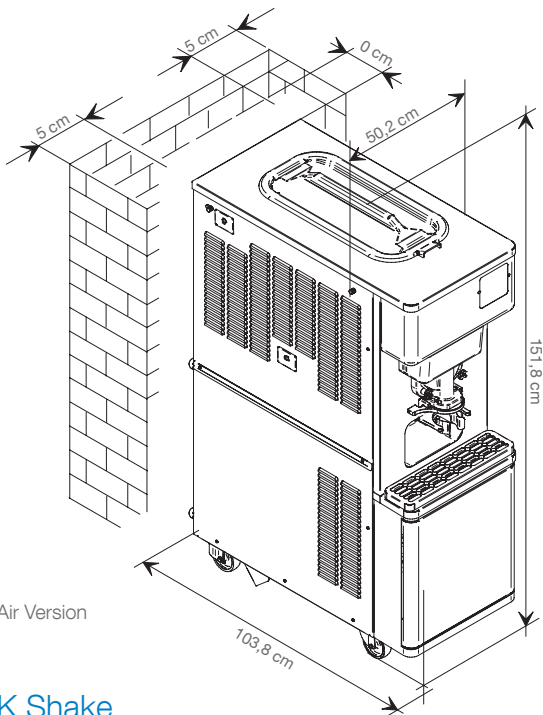

Air Version

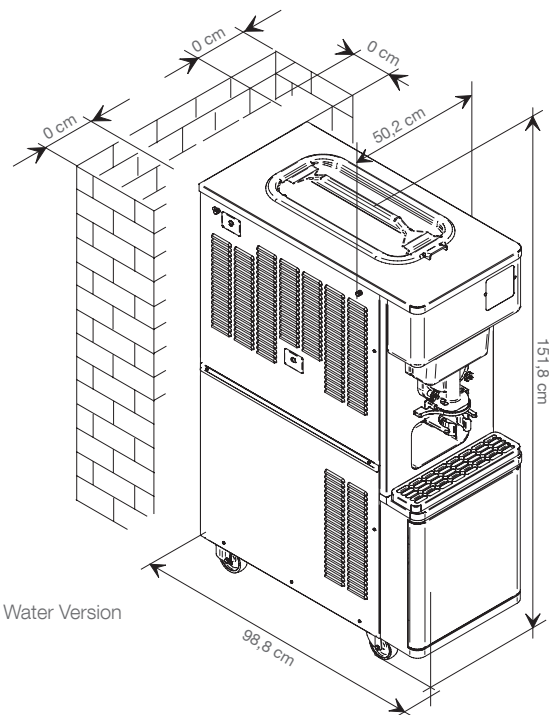

Water Version

K Shake

# 191 K SP K Shake



		Flavours	Mix Delivery System	Hourly production	Tank Capacity	Cylinder Capacity	Rated Power Input	Fuse Size	Power Supply	Cooling System	Refrigerant	Net Weight
					lt	lt	kW	A	Volt Hz Ph			kg
191 K SP	P	1	Pump	(16oz / 0,4lt)	12	7	2,4	10	400/50/3**	Air, water optional	R452***	170
	G		Gravity	130*	16		2,2					143
K Shake	P	1+4 syrups	Pump	(400ml portions) 210*	20	7	2,5	12	400/50/3**	Air, water optional	R452***	260

\*production capacity depends on the mix used and the room temperature \*\*other voltages and cycles available upon request  
\*\*\*alternative solutions available.

Shake machines are produced by Carpigiani with UNI EN ISO 9001 Certified Quality System.

All specifications mentioned must be considered approximate; Carpigiani reserves the right to modify, without notice, all parts deemed necessary.



Via Emilia, 45 - 40011 Anzola dell'Emilia - BOLOGNA, Italy - T. +39 051 6505111 - info@carpigiani.it

an Ali Group Company



The Spirit of Excellence